

Quick Tip 19317

Wallmount Instructions for SoundPoint® IP Phones



This quick tip provides step-by-step instructions for mounting your SoundPoint IP phone to a wall.

Introduction

Instead of using your phone on a tabletop or desktop, you may wish to mount your SoundPoint IP telephone to a wall.

Depending on which model you own, your SoundPoint IP phone can be mounted to the wall in one of two ways:

- By using the reversible base stand/wallmount unit (included with SoundPoint IP 32x/33x and 430 phones).
- By using the separate wallmount accessory available from your reseller (for SoundPoint IP 450, 550, 560, 650, and 670 phones). For more information on purchasing a separate wallmount accessory, contact your reseller.

Wall anchors and applicable tools are required for wallmount installation. These are *not* included with your SoundPoint IP telephone, or separate wallmount accessory.

Repositioning the Hookswitch Tab

Regardless of which model you have, your SoundPoint IP phone comes equipped with a reversible hookswitch tab. This tab allows the handset to stay on-hook when the phone is mounted vertically.

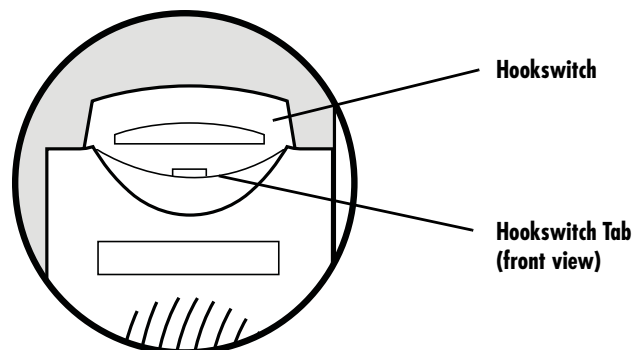

Your SoundPoint IP phone is packaged with the hookswitch tab in "deskmount" position. Before your phone can be mounted to the wall, the hookswitch tab must be set to the "wallmount" position.

To reposition the hookswitch tab for wallmount use:

1. Locate the hookswitch tab on the back of the phone (see below).

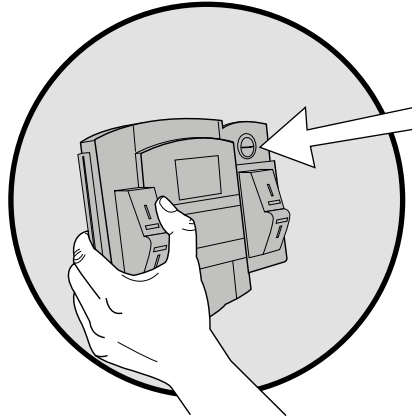

2. Using your thumb or forefinger, push the tab downward.

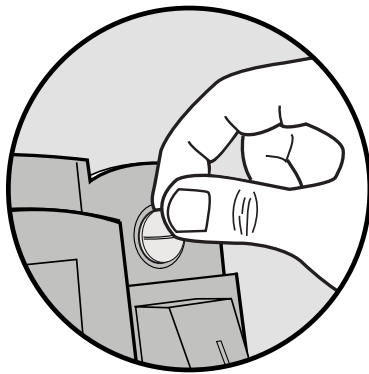

3. Using your thumb or forefinger, bring the tab out.

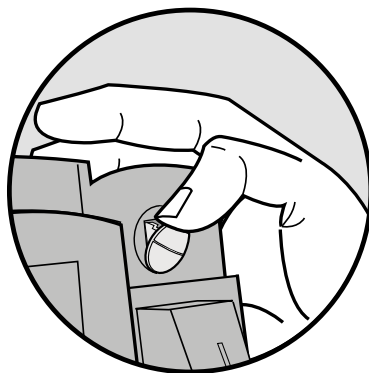

- The hookswitch tab is now unlocked.

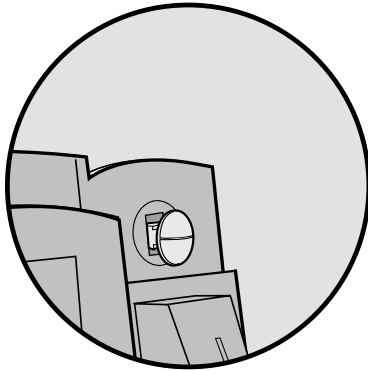

4. Remove the hookswitch tab, as shown below.

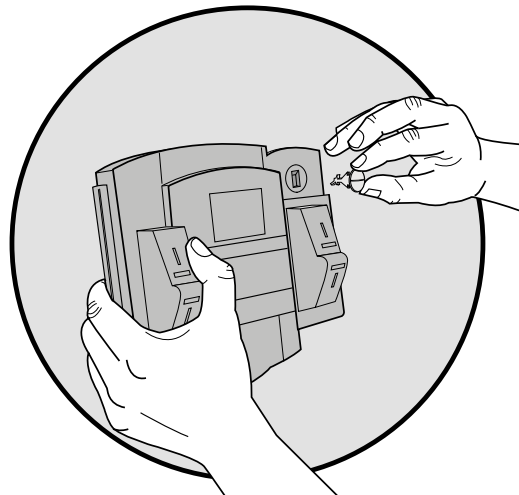
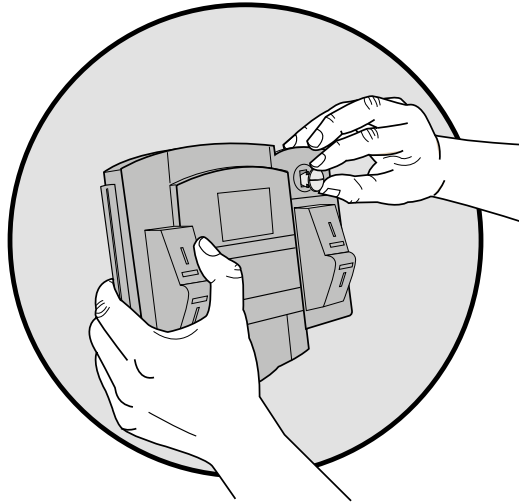

5. Rotate the hookswitch tab so that the outermost extension is pointing up (as shown below).

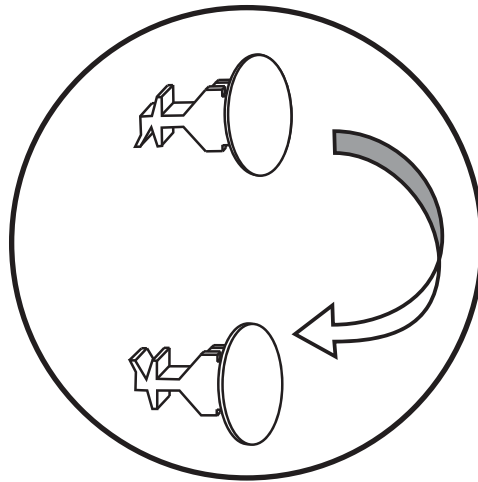
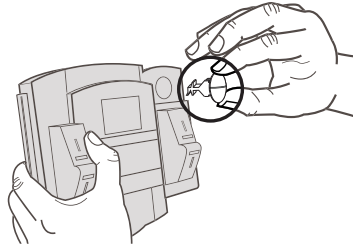

6. Re-insert the hookswitch tab, and then push it into a locked position, using your thumb. The hookswitch tab is now in "wallmount" position.

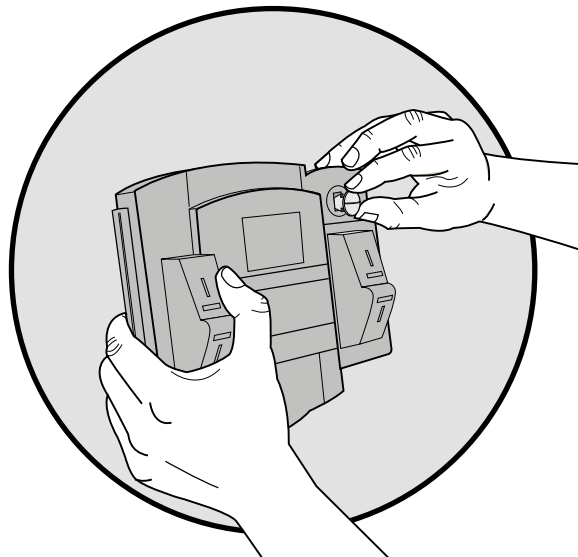

Attaching the Reversible Base Stand/Wallmount Unit

The reversible base stand unit (shown below) can be used either for desktop/tabletop use, or for wallmount use.

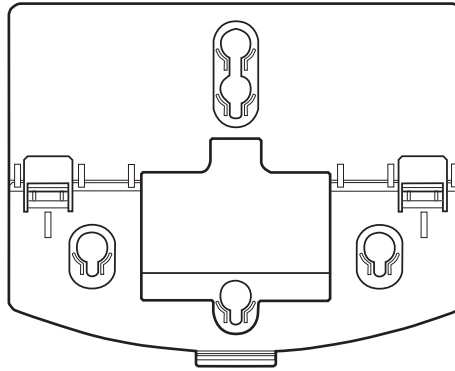

The reversible base stand is included with the following SoundPoint IP telephones:

- SoundPoint IP 32x/33x
- SoundPoint IP 430

If your phone is not included in the above list, see “Attaching the Separate Wallmount Accessory”, in the next section.

If you are not sure which SoundPoint IP model you are using, check the back of the phone for the model label, or contact your reseller.

To install the reversible base stand/wallmount unit:

1. Using wall anchors (not provided), attach the base stand unit to the wall, with the mounting tab facing up, as shown.

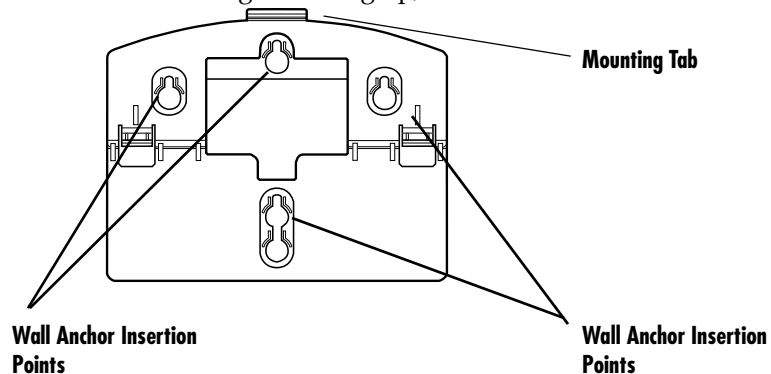

2. Attach all applicable cords and cables to your SoundPoint IP telephone.
For more information about attaching cords and cables, see your SoundPoint IP telephone’s Quick Start Guide or User Guide.

3. Snap your SoundPoint IP telephone into place.

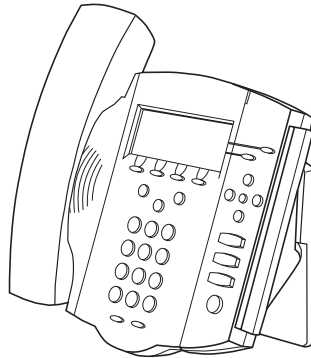

Attaching the Separate Wallmount Accessory

The separate wallmount accessory (shown below) can be used only for wallmount usage, and is available from your reseller.



The separate wallmount accessory is available for the following SoundPoint IP telephones:

- SoundPoint IP 450
- SoundPoint IP 550
- SoundPoint IP 560
- SoundPoint IP 650
- SoundPoint IP 670

If your phone is not included in the above list, see “Attaching the Reversible base Stand/Wallmount Unit”, in the previous section.

If you are not sure which SoundPoint IP model you are using, check the back of the phone for the model label, or contact your reseller.

To install the separate wallmount accessory:

1. Using wall anchors (not provided), attach the wallmount accessory to the wall, as shown.
2. Attach all applicable cords and cables to your SoundPoint IP telephone.

For more information about attaching cords and cables, see your

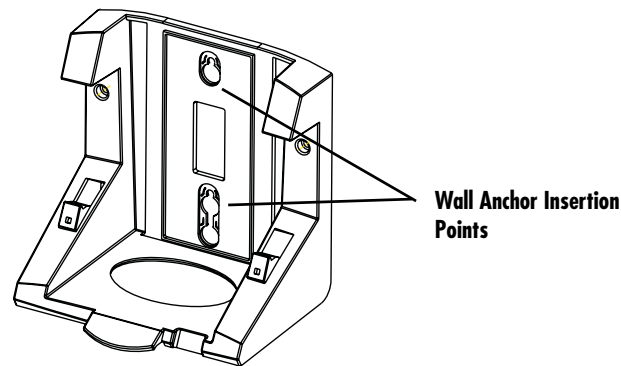

SoundPoint IP telephone's Quick Start Guide or User Guide.

3. Snap your SoundPoint IP telephone into place.

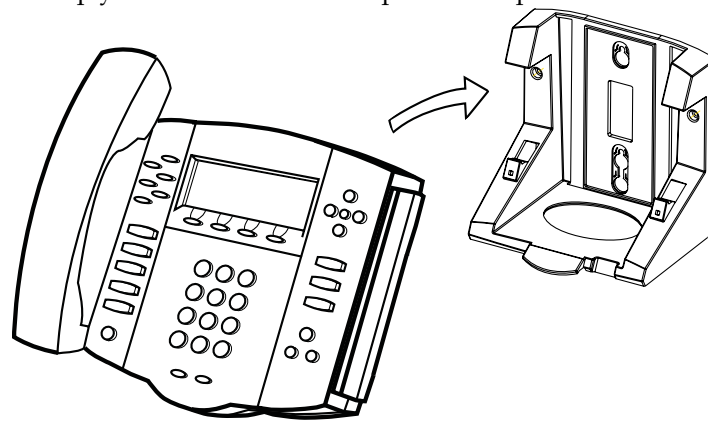

Trademark Information

Polycom®, SoundPoint®, and the Polycom logo design are registered trademarks of Polycom, Inc. in the U.S. and various countries. All other trademarks are the property of their respective companies.